

# INSTALL/REMOVAL INSTRUCTIONS: AIR SUSPENSION CONVERSION KIT

**ATTENTION:** Refer to the appropriate shop manual for your vehicle to obtain specific service procedures for this part. If you do not have a service manual or lack the skill to install this part, it is recommended that you seek the services of a qualified technician. Pay special attention to all cautions and warnings included in the shop manual. Read and follow all instructions carefully.

## Air Suspension Conversion Kit

### General Installation Instructions

When servicing any vehicle be sure to follow all safety procedures. First, make sure that when lifting the vehicle that you use an appropriate jack with a proper weight rating. Before going underneath any vehicle, make sure that it is properly supported with sturdy jack stands and on level ground so that the vehicle doesn't fall or slide off of the jack and onto you. As with any automotive repair, make sure you have the appropriate tools to do the job so you don't damage any parts on the vehicle. Safety glasses and mechanic's gloves should also be worn for your protection.

Take care not to exceed the Gross Vehicle Weight Rating (GVWR), or the maximum load recommended by the manufacturer. It is important that all the vehicle owner manuals recommendations are followed for your own safety and to prevent damage to the vehicle.

Once you are ready to disable the ride light, you will need to disconnect the negative battery cable (-) to prevent electrical shock/malfunction.

Detailed instructions by application are available at: <https://www.dormanproducts.com>

If you have any further questions or concerns about this installation please give our Tech Support Line a call at 1-800-523-2492.

#### Disclaimer:

Even though every attempt is made to ensure this information is complete and accurate, it is impossible to account for all possible circumstances or situations. Please consult with a qualified auto technician before attempting to perform any work you are not qualified to do. Automobiles can be hazardous to work on; be sure to take all necessary safety precautions. Failure to do so may result in property damage or personal injury. Certain motor vehicle standards and performance requirements may apply to your motor vehicle (such as Federal Motor Vehicle Safety Standards by the National Highway Traffic Safety Administration). Be sure that your work is performed in accordance with such standards and that you do not disable any motor vehicle safety feature.

©2018 Dorman Products, Inc.

No reproductions in whole or in part without prior written approval.

**ATTENTION:** Refer to the appropriate shop manual for your vehicle to obtain specific service procedures for this part. If you do not have a service manual or lack the skill to install this part, it is recommended that you seek the services of a qualified technician. Pay special attention to all cautions and warnings included in the shop manual. Read and follow all instructions carefully.

## Quick Start Guide

### 1990 – 2008 Lincoln Town Car

### 1990 – 2008 Ford Crown Victoria

### 1990 – 2008 Mercury Grand Marquis

## Rear Suspension Kit

### Parts included in this kit

- (2) Coil springs
- (2) shocks



- (2) Rear upper spring isolators



### Tools needed for installation

- Metric socket set
- Floor jack
- Jack stands
- Metric wrenches
- Screw drivers (Phillips and flat head)
- Wire cutter/stripper/crimping tool
- Level work surface
- Metric socket set

Disclaimer:

Even though every attempt is made to ensure this information is complete and accurate, it is impossible to account for all possible circumstances or situations. Please consult with a qualified auto technician before attempting to perform any work you are not qualified to do. Automobiles can be hazardous to work on; be sure to take all necessary safety precautions. Failure to do so may result in property damage or personal injury. Certain motor vehicle standards and performance requirements may apply to your motor vehicle (such as Federal Motor Vehicle Safety Standards by the National Highway Traffic Safety Administration). Be sure that your work is performed in accordance with such standards and that you do not disable any motor vehicle safety feature.

©2018 Dorman Products, Inc.

No reproductions in whole or in part without prior written approval.

**ATTENTION:** Refer to the appropriate shop manual for your vehicle to obtain specific service procedures for this part. If you do not have a service manual or lack the skill to install this part, it is recommended that you seek the services of a qualified technician. Pay special attention to all cautions and warnings included in the shop manual. Read and follow all instructions carefully.

## Troubleshooting Guide

### The “Check Air Suspension” light won’t go out.

- Clear any codes from the vehicle’s computer.
- Verify that the Air Suspension switch is in the “ON” position.
- Ensure that the compressor is on the car and the fuse is good.
- Verify that the solenoids are on the electrical connector on the car.
- Check to make sure the solenoid is operating properly.
- Verify the correct wire has been cut to disarm the light.
- Disconnect both battery cables from the car and hold them together for ten seconds. After five minutes, reconnect the cables. This will reset the whole system.

### The compressor still runs

- Ensure that the solenoids are in good, working condition.
- Locate the ride height sensor on the left rear axle. It will have a rubber accordion style cover. Disconnect it from the axle and let it hang in the neutral position.

### Noises are heard

- Before calling in check the following items:
  - Check to ensure all bolts are tight.
  - Ensure that the shock bushings and hardware have been assembled properly and are tight.
  - Visually inspect and try to move all suspension components.
  - Air suspension often hides other faulty components.

### The springs won’t go in

- Make sure you have both wheels off the ground! The stabilizer end links need to be removed

#### Disclaimer:

Even though every attempt is made to ensure this information is complete and accurate, it is impossible to account for all possible circumstances or situations. Please consult with a qualified auto technician before attempting to perform any work you are not qualified to do. Automobiles can be hazardous to work on; be sure to take all necessary safety precautions. Failure to do so may result in property damage or personal injury. Certain motor vehicle standards and performance requirements may apply to your motor vehicle (such as Federal Motor Vehicle Safety Standards by the National Highway Traffic Safety Administration). Be sure that your work is performed in accordance with such standards and that you do not disable any motor vehicle safety feature.

©2018 Dorman Products, Inc.

No reproductions in whole or in part without prior written approval.

**ATTENTION:** Refer to the appropriate shop manual for your vehicle to obtain specific service procedures for this part. If you do not have a service manual or lack the skill to install this part, it is recommended that you seek the services of a qualified technician. Pay special attention to all cautions and warnings included in the shop manual. Read and follow all instructions carefully.

## TOWN CAR, GRAND MARQUIS, CROWN VICTORIA AIR SPRING REMOVAL

- Turn off the Air Suspension switch in the trunk. (Located in the trunk on the right side)



- Lift and support the rear of the vehicle. Always use extreme caution when lifting and supporting any vehicle.
- Remove the rear wheels.
- Remove the upper Air Spring retaining clip. (Accessed through the gap between the frame rail and the body)

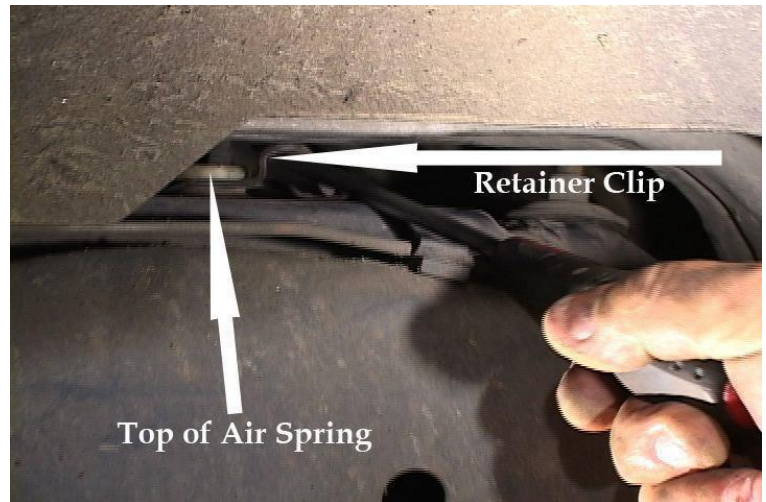

Disclaimer:

Even though every attempt is made to ensure this information is complete and accurate, it is impossible to account for all possible circumstances or situations. Please consult with a qualified auto technician before attempting to perform any work you are not qualified to do. Automobiles can be hazardous to work on; be sure to take all necessary safety precautions. Failure to do so may result in property damage or personal injury. Certain motor vehicle standards and performance requirements may apply to your motor vehicle (such as Federal Motor Vehicle Safety Standards by the National Highway Traffic Safety Administration). Be sure that your work is performed in accordance with such standards and that you do not disable any motor vehicle safety feature.

©2018 Dorman Products, Inc.

No reproductions in whole or in part without prior written approval.

**ATTENTION:** Refer to the appropriate shop manual for your vehicle to obtain specific service procedures for this part. If you do not have a service manual or lack the skill to install this part, it is recommended that you seek the services of a qualified technician. Pay special attention to all cautions and warnings included in the shop manual. Read and follow all instructions carefully.

## TOWN CAR, GRAND MARQUIS, CROWN VICTORIA AIR SPRING REMOVAL

- Using a pry bar or large screw driver, remove the lower spring seat from the axle assembly.
- Make sure to also remove the retaining clip from the lower spring seat.
- It may be necessary to puncture the air bag if all air has not been vented to ease removal.



- Remove the Air Spring solenoid clip. Rotate the solenoid counterclockwise to the first stop.
- To bleed the air from the system pull the solenoid straight out slowly to the second stop.
- After the air is completely bled from the system, rotate the solenoid counterclockwise to the third stop and remove solenoid from the Air Spring.



Disclaimer:

Even though every attempt is made to ensure this information is complete and accurate, it is impossible to account for all possible circumstances or situations. Please consult with a qualified auto technician before attempting to perform any work you are not qualified to do. Automobiles can be hazardous to work on; be sure to take all necessary safety precautions. Failure to do so may result in property damage or personal injury. Certain motor vehicle standards and performance requirements may apply to your motor vehicle (such as Federal Motor Vehicle Safety Standards by the National Highway Traffic Safety Administration). Be sure that your work is performed in accordance with such standards and that you do not disable any motor vehicle safety feature.

©2018 Dorman Products, Inc.

No reproductions in whole or in part without prior written approval.

**ATTENTION:** Refer to the appropriate shop manual for your vehicle to obtain specific service procedures for this part. If you do not have a service manual or lack the skill to install this part, it is recommended that you seek the services of a qualified technician. Pay special attention to all cautions and warnings included in the shop manual. Read and follow all instructions carefully.

## Town Car, Grand Marquis, Crown Victoria Air Spring Removal

- Leave the solenoid connected to the air line and the electrical connector. Solenoid must stay with the vehicle.



- Remove the lower shock mounting nuts and pull the shocks away from the axle. This will allow the axle to lower during the installation of the new springs.



Disclaimer:

Even though every attempt is made to ensure this information is complete and accurate, it is impossible to account for all possible circumstances or situations. Please consult with a qualified auto technician before attempting to perform any work you are not qualified to do. Automobiles can be hazardous to work on; be sure to take all necessary safety precautions. Failure to do so may result in property damage or personal injury. Certain motor vehicle standards and performance requirements may apply to your motor vehicle (such as Federal Motor Vehicle Safety Standards by the National Highway Traffic Safety Administration). Be sure that your work is performed in accordance with such standards and that you do not disable any motor vehicle safety feature.

©2018 Dorman Products, Inc.

No reproductions in whole or in part without prior written approval.

**ATTENTION:** Refer to the appropriate shop manual for your vehicle to obtain specific service procedures for this part. If you do not have a service manual or lack the skill to install this part, it is recommended that you seek the services of a qualified technician. Pay special attention to all cautions and warnings included in the shop manual. Read and follow all instructions carefully.

## Town Car, Grand Marquis, Crown Victoria Rear Coil Spring Installation

- Install the coil spring into the upper seat with the tighter wound coils on top.
- Be sure to install the larger end of spring into upper isolator with smaller end down. **Note:** Lowering the axle a few inches will help with this step. When installed, the end of the pigtail should be facing the tire (outward).



- If replacing the shocks as well, remove the old shock and install the new shock. Install the upper mount of the shock first. Continue as directed.
- Raise the axle and install the lower shock bolt and nut. Tighten all hardware.
- Secure all loose wiring and air lines, with wire ties, to prevent them from touching the exhaust pipes.
- Reinstall the wheels and lower the vehicle to the ground.



Disclaimer:

Even though every attempt is made to ensure this information is complete and accurate, it is impossible to account for all possible circumstances or situations. Please consult with a qualified auto technician before attempting to perform any work you are not qualified to do. Automobiles can be hazardous to work on; be sure to take all necessary safety precautions. Failure to do so may result in property damage or personal injury. Certain motor vehicle standards and performance requirements may apply to your motor vehicle (such as Federal Motor Vehicle Safety Standards by the National Highway Traffic Safety Administration). Be sure that your work is performed in accordance with such standards and that you do not disable any motor vehicle safety feature.

©2018 Dorman Products, Inc.

No reproductions in whole or in part without prior written approval.

**ATTENTION:** Refer to the appropriate shop manual for your vehicle to obtain specific service procedures for this part. If you do not have a service manual or lack the skill to install this part, it is recommended that you seek the services of a qualified technician. Pay special attention to all cautions and warnings included in the shop manual. Read and follow all instructions carefully.

## Lincoln Town Car Suspension Module Locations Lincoln Town Car Locations

### 1990-1994 Lincoln Town Car

- The module will be located on the back side of the right rear trunk support.



### 1995-2002 Lincoln Town Car

- The module is located behind the glove box.



Disclaimer:

Even though every attempt is made to ensure this information is complete and accurate, it is impossible to account for all possible circumstances or situations. Please consult with a qualified auto technician before attempting to perform any work you are not qualified to do. Automobiles can be hazardous to work on; be sure to take all necessary safety precautions. Failure to do so may result in property damage or personal injury. Certain motor vehicle standards and performance requirements may apply to your motor vehicle (such as Federal Motor Vehicle Safety Standards by the National Highway Traffic Safety Administration). Be sure that your work is performed in accordance with such standards and that you do not disable any motor vehicle safety feature.

©2018 Dorman Products, Inc.

No reproductions in whole or in part without prior written approval.



**ATTENTION:** Refer to the appropriate shop manual for your vehicle to obtain specific service procedures for this part. If you do not have a service manual or lack the skill to install this part, it is recommended that you seek the services of a qualified technician. Pay special attention to all cautions and warnings included in the shop manual. Read and follow all instructions carefully.

## Lincoln Town Car Light Out Instructions

**1990-1994 LINCOLN TOWN CAR**  
**1996-1997 LINCOLN TOWN CAR**

- Unbolt the control module to access the connectors.
- Cut the dark green wire with the lime green stripe.
- The wire is located in the black connector, pin number 11.
- Make certain the suspension system is switched off prior to cutting wires.

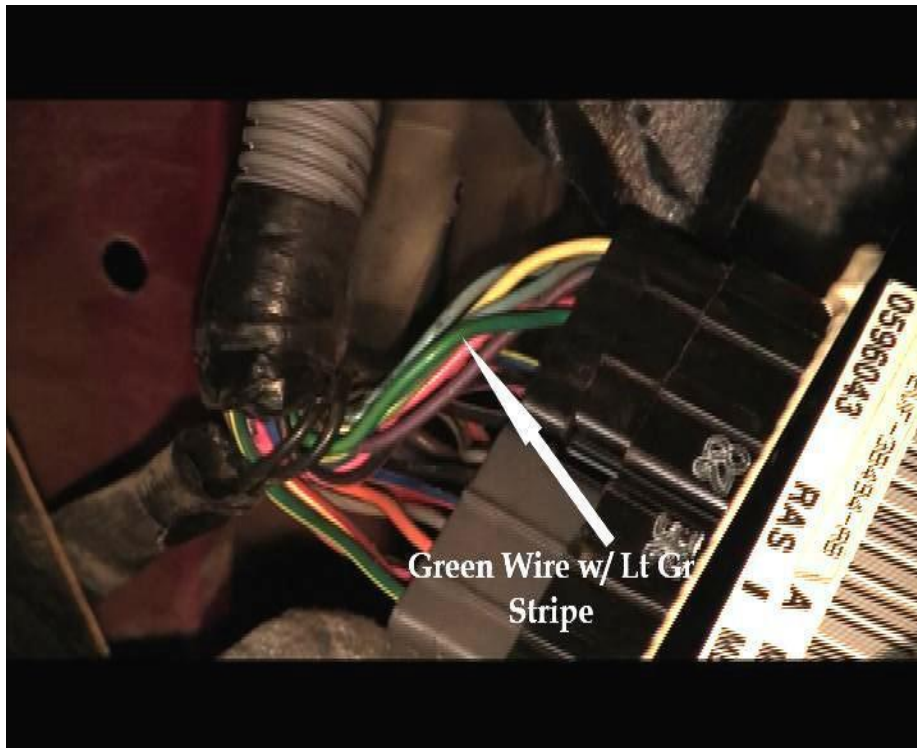

- **Caution:** Do not cut the green wire with the yellow stripe located in the grey connector
- Turn the suspension switch back to the on position.

Installation is now complete.

Disclaimer:

Even though every attempt is made to ensure this information is complete and accurate, it is impossible to account for all possible circumstances or situations. Please consult with a qualified auto technician before attempting to perform any work you are not qualified to do. Automobiles can be hazardous to work on; be sure to take all necessary safety precautions. Failure to do so may result in property damage or personal injury. Certain motor vehicle standards and performance requirements may apply to your motor vehicle (such as Federal Motor Vehicle Safety Standards by the National Highway Traffic Safety Administration). Be sure that your work is performed in accordance with such standards and that you do not disable any motor vehicle safety feature.

©2018 Dorman Products, Inc.

No reproductions in whole or in part without prior written approval.

**ATTENTION:** Refer to the appropriate shop manual for your vehicle to obtain specific service procedures for this part. If you do not have a service manual or lack the skill to install this part, it is recommended that you seek the services of a qualified technician. Pay special attention to all cautions and warnings included in the shop manual. Read and follow all instructions carefully.

## Lincoln Town Car Light Out Instructions

### 1995 Lincoln town Car only

- Look for the white connector. Cut the dark green wire with the lime green stripe in pin number 11. Make certain the suspension system is off prior to cutting wires.

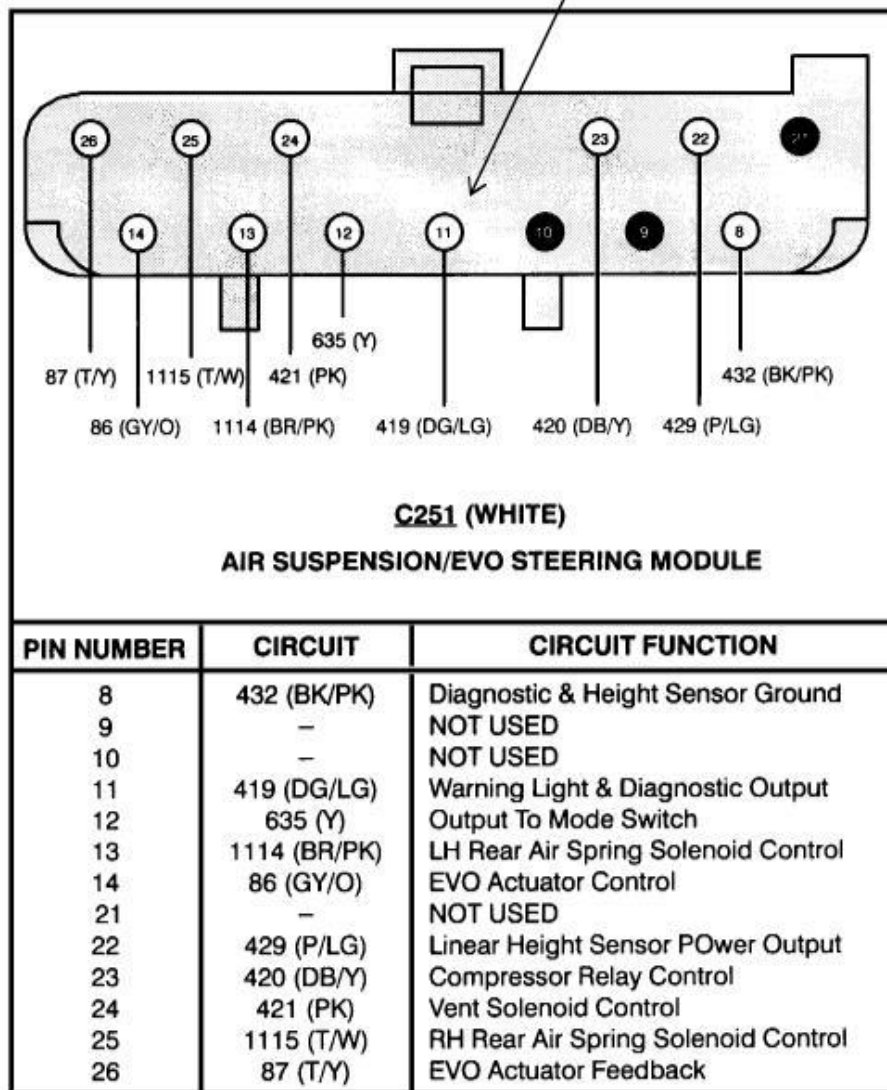

- Turn the air switch back on after cutting wire.

Disclaimer:

Even though every attempt is made to ensure this information is complete and accurate, it is impossible to account for all possible circumstances or situations. Please consult with a qualified auto technician before attempting to perform any work you are not qualified to do. Automobiles can be hazardous to work on; be sure to take all necessary safety precautions. Failure to do so may result in property damage or personal injury. Certain motor vehicle standards and performance requirements may apply to your motor vehicle (such as Federal Motor Vehicle Safety Standards by the National Highway Traffic Safety Administration). Be sure that your work is performed in accordance with such standards and that you do not disable any motor vehicle safety feature.

©2018 Dorman Products, Inc.

No reproductions in whole or in part without prior written approval.

**ATTENTION:** Refer to the appropriate shop manual for your vehicle to obtain specific service procedures for this part. If you do not have a service manual or lack the skill to install this part, it is recommended that you seek the services of a qualified technician. Pay special attention to all cautions and warnings included in the shop manual. Read and follow all instructions carefully.

## Lincoln Town Car Light Out Instructions

### 1998-2002 Lincoln Town Car

- The module is located behind the glove box. Remove the glove box and the module will be on the right hand side.
- Locate the black connector. The pink wire with the light blue stripe will need to be cut.

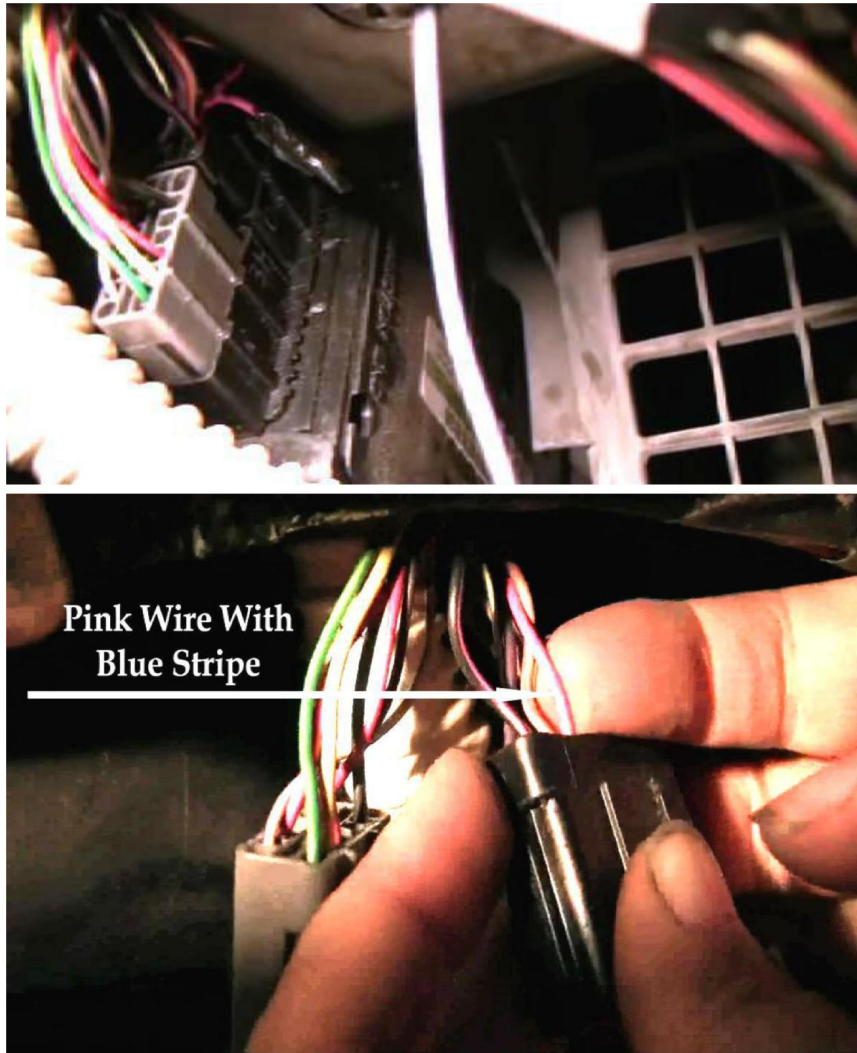

- Turn the suspension switch back to the on position when completed.

Disclaimer:

Even though every attempt is made to ensure this information is complete and accurate, it is impossible to account for all possible circumstances or situations. Please consult with a qualified auto technician before attempting to perform any work you are not qualified to do. Automobiles can be hazardous to work on; be sure to take all necessary safety precautions. Failure to do so may result in property damage or personal injury. Certain motor vehicle standards and performance requirements may apply to your motor vehicle (such as Federal Motor Vehicle Safety Standards by the National Highway Traffic Safety Administration). Be sure that your work is performed in accordance with such standards and that you do not disable any motor vehicle safety feature.

©2018 Dorman Products, Inc.

No reproductions in whole or in part without prior written approval.

**ATTENTION:** Refer to the appropriate shop manual for your vehicle to obtain specific service procedures for this part. If you do not have a service manual or lack the skill to install this part, it is recommended that you seek the services of a qualified technician. Pay special attention to all cautions and warnings included in the shop manual. Read and follow all instructions carefully.

## Lincoln Town Car Light Out Instructions

### 2003-2005 and 2007-2011 Lincoln Town Car 2007-2011 Grand Marquis & Crown Victoria

- The electrical portion of the system must be maintained for the vehicle's message center to operate for other functions.
- To cancel the "Service Air Suspension" message, it is necessary to make the Air Leveling Valve stationary. Disconnect the Level Valve Link and secure it in a stationary position. The level arm needs to be tied off in a level position--Usually even with the center of the Level Sensor.

Suspension Height Sensor

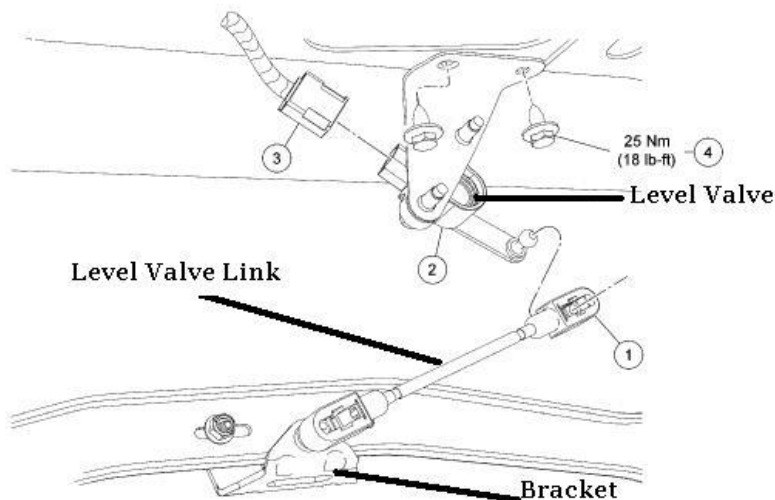

- The Air Suspension switch must be turned on.
- Failure to secure the Level Valve arm will result in a warning message, but will not affect the operation of the vehicle.

### 2006 Lincoln Town Car only

- Cut the dark green wire with the lime green stripe and turn the Air Switch back to the "on" position. The wire is in pin number 11.

C2131B (BK)

14A005  
AIR SUSPENSION MODULE (3C142)



Pin	Circuit	Gauge	Circuit Function	Qualifier
8	432 (BK-PK)	20	Air suspension module ground	
9	914 (TN-OG)	22	SCP Bus +	
10	915 (PK-LB)	22	SCP Bus -	
11	419 (DG-LG)	22	Warning lamp signal	
12	427 (PK-BK)	20	Air suspension height sensor signal	
13	1114 (BR-PK)	20	Air spring solenoid valve control, left rear	
14	114 (LB-YE)	20	Power steering valve solenoid +	
21	-	-	Not Used	
22	417 (VT-OG)	20	Air suspension disable switch +	
23	420 (DB-YE)	20	Air suspension compressor relay control	
24	421 (PK)	20	Air suspension compressor, vent	
25	1115 (TN-WH)	20	Air spring solenoid valve control, right rear	
26	115 (LG-BK)	20	Power steering valve solenoid -	

Disclaimer:

Even though every attempt is made to ensure this information is complete and accurate, it is impossible to account for all possible circumstances or situations. Please consult with a qualified auto technician before attempting to perform any work you are not qualified to do. Automobiles can be hazardous to work on; be sure to take all necessary safety precautions. Failure to do so may result in property damage or personal injury. Certain motor vehicle standards and performance requirements may apply to your motor vehicle (such as Federal Motor Vehicle Safety Standards by the National Highway Traffic Safety Administration). Be sure that your work is performed in accordance with such standards and that you do not disable any motor vehicle safety feature.

©2018 Dorman Products, Inc.

No reproductions in whole or in part without prior written approval.

**ATTENTION:** Refer to the appropriate shop manual for your vehicle to obtain specific service procedures for this part. If you do not have a service manual or lack the skill to install this part, it is recommended that you seek the services of a qualified technician. Pay special attention to all cautions and warnings included in the shop manual. Read and follow all instructions carefully.

## Mercury Grand Marquis Ford Crown Victoria Light Out Instructions

### 1990-1994 Mercury Grand Marquis 1990-1994 Ford Crown Victoria

- Module is located in the right rear of the trunk.

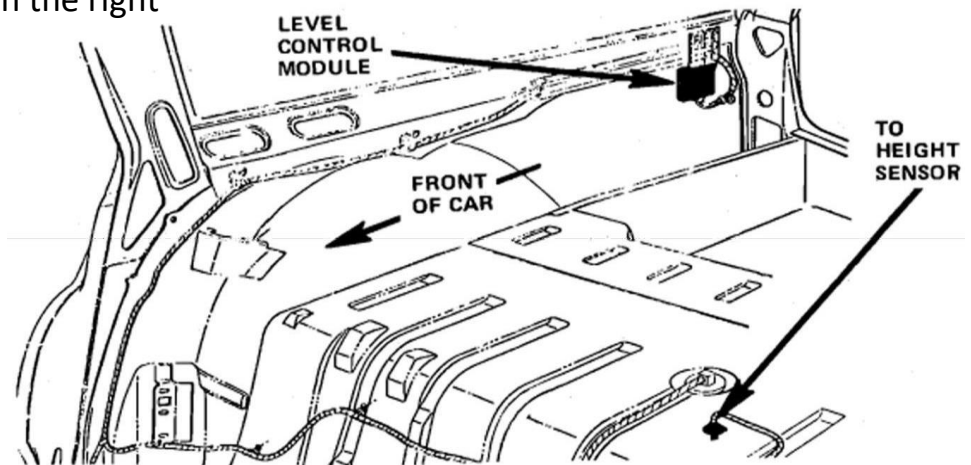

- Look for the dark green wire with the lime green stripe and cut this wire.
- Turn the Suspension Switch back to the on position.

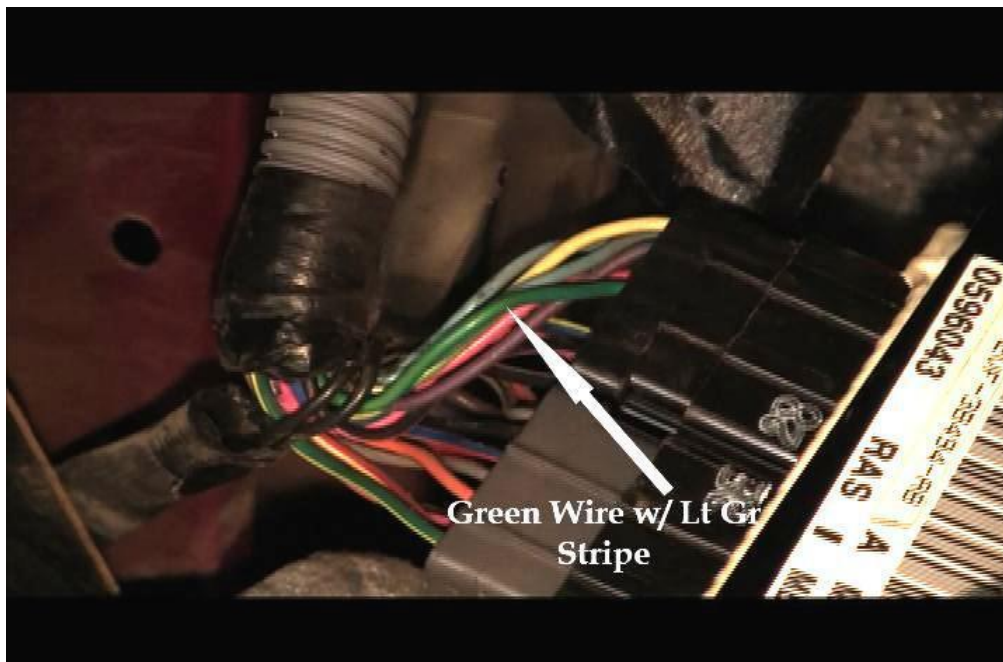

Disclaimer:

Even though every attempt is made to ensure this information is complete and accurate, it is impossible to account for all possible circumstances or situations. Please consult with a qualified auto technician before attempting to perform any work you are not qualified to do. Automobiles can be hazardous to work on; be sure to take all necessary safety precautions. Failure to do so may result in property damage or personal injury. Certain motor vehicle standards and performance requirements may apply to your motor vehicle (such as Federal Motor Vehicle Safety Standards by the National Highway Traffic Safety Administration). Be sure that your work is performed in accordance with such standards and that you do not disable any motor vehicle safety feature.

©2018 Dorman Products, Inc.

No reproductions in whole or in part without prior written approval.

**ATTENTION:** Refer to the appropriate shop manual for your vehicle to obtain specific service procedures for this part. If you do not have a service manual or lack the skill to install this part, it is recommended that you seek the services of a qualified technician. Pay special attention to all cautions and warnings included in the shop manual. Read and follow all instructions carefully.

## Mercury Grand Marquis Ford Crown Victoria Light Out Instructions

### 1995-2006 Mercury Grand Marquis 1995-2006 Ford Crown Victoria

- The control module is located behind the glove box.



- Cut the dark green with lime green striped wire that is in the black connector, pin number 11.
- Do not cut the green wire with yellow stripe on the grey connector.
- Turn the suspension switch back on when completed.

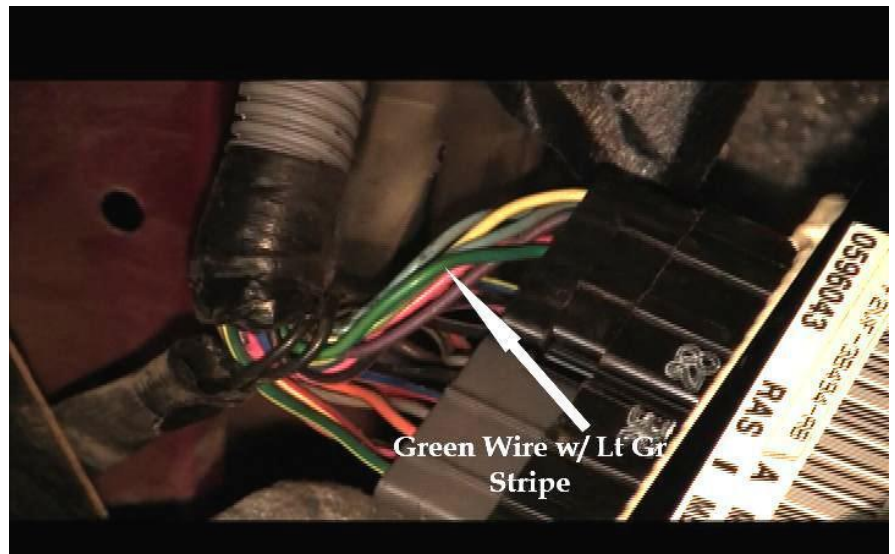

Disclaimer:

Even though every attempt is made to ensure this information is complete and accurate, it is impossible to account for all possible circumstances or situations. Please consult with a qualified auto technician before attempting to perform any work you are not qualified to do. Automobiles can be hazardous to work on; be sure to take all necessary safety precautions. Failure to do so may result in property damage or personal injury. Certain motor vehicle standards and performance requirements may apply to your motor vehicle (such as Federal Motor Vehicle Safety Standards by the National Highway Traffic Safety Administration). Be sure that your work is performed in accordance with such standards and that you do not disable any motor vehicle safety feature.

©2018 Dorman Products, Inc.

No reproductions in whole or in part without prior written approval.